



Performance is everything.™

# User Guide

Vax Careline: AU: 1300 361 505

NZ: 0800 800 900

## Wash 'n' Dry Canister

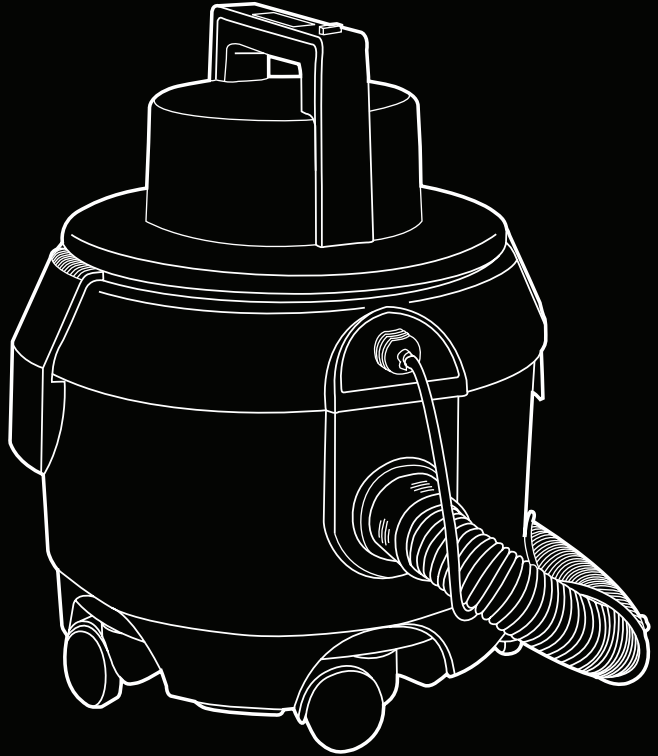

### Get Cleaning...

What's your Vax's model number?

3 0 0 0 0

What's your serial number? (Located on the handle of the machine)

Note these down in case you need them in future. Please keep instructions for further use.

Vax Service line: AU: 1300 361 505  
NZ: 0800 800 900

# Machine Overview

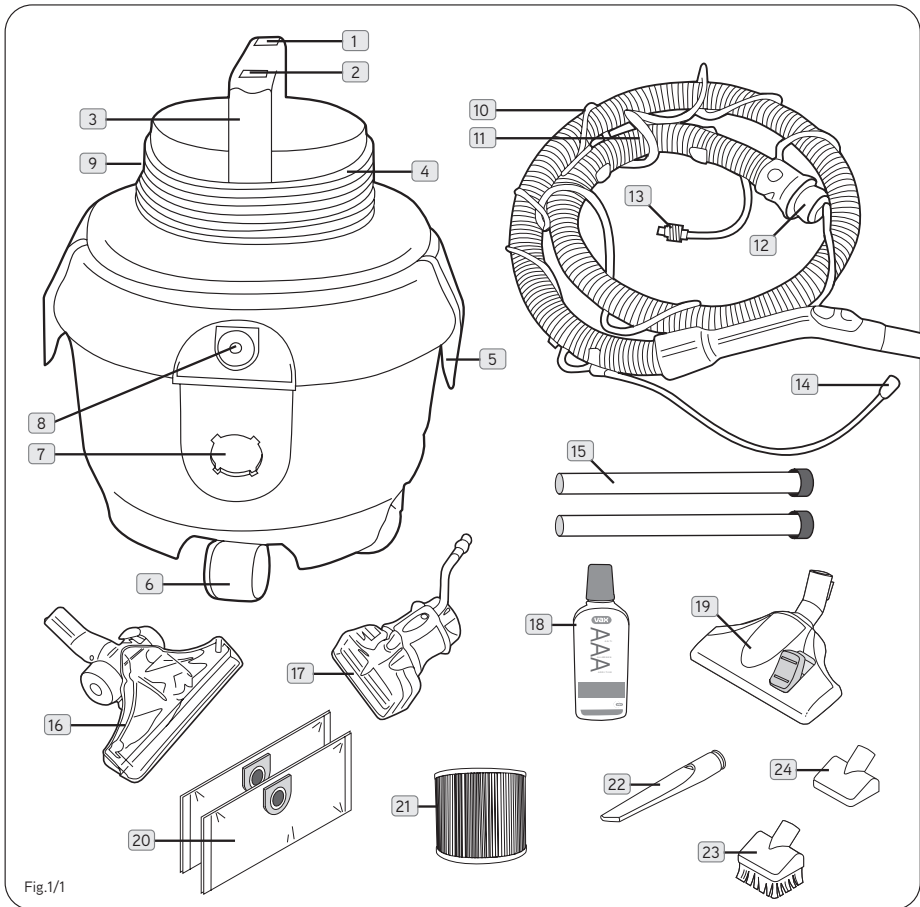

Fig.1/1

- |                                |   |
|--------------------------------|---|
| 1 Water pump button (green)    | 13 Solution tube to machine connector                   |
| 2 Power button (red)           | 14 Solution tube to wash head/upholstery tool connector |
| 3 Carry handle                 | 15 2 x stainless steel extension tubes                  |
| 4 Power cord                   | 16 Fibreflow carpet wash head                           |
| 5 Container release clips      | 17 Upholstery wash tool                                 |
| 6 Casters                      | 18 Vax Carpet Cleaning Solution                         |
| 7 Suction hose connection port | 19 Combination floor head (for dry vacuuming)           |
| 8 Solution tube port           | 20 2 x paper dustbags                                   |
| 9 Exhaust filter               | 21 Filter assembly                                      |
| 10 Hose                        | 22 Crevice tool   |
| 11 Solution tube               | 23 Dusting brush  |
| 12 Suction hose connector      | 24 Upholstery tool                                      |

# General Safety Information

## FOR HOUSEHOLD USE ONLY.

When using the vacuum cleaner, basic safety precautions should always be observed, including the following:

1. Do not leave the multifunction machine unattended when plugged in. Unplug it from the socket when not in use.
2. To prevent electric shock do not use outdoors.
3. Not to be used as a toy.
4. Children should be supervised to ensure that they do not play with the appliance.
5. This appliance is not intended for use by persons (including children) with reduced physical, sensory or mental capabilities, or lack of experience and knowledge, unless they have been given supervision or instruction concerning the use of the appliance by a person responsible for their safety.
6. Use only as described in this manual. Use only Vax recommended attachments.
7. Do not use the vacuum cleaner if it has been dropped, damaged, left outdoors or dropped into water. Do not use the vacuum cleaner with a damaged cord or plug. If the supply cord is damaged, it must be replaced by the manufacturer or a recommended service agent to avoid a hazard..
8. Do not handle the plug or multifunction machine with wet hands. Do not use outdoors.
9. Do not pull or carry by cord. Do not use cord as a handle, close a door on the cord or pull cord around sharp edges or corners. Do not run the multifunction machine over the cord. Keep the cord away from heated surfaces.
10. Do not put any objects into openings or operate with openings blocked. Keep them free of anything that might reduce airflow.
11. Keep hair, loose clothing, fingers and all parts of body away from openings and moving parts.
12. Do not vacuum hot coals, cigarette butts, matches or any hot, smoking or burning objects including ash.
13. Do not use the carpet washing function without the solution tank and dirty water tank in place.
14. Do not use the vacuum for dry cleaning without the dust bag in place.
15. Turn off all controls before unplugging.
16. Do not vacuum harmful or toxic material (chlorine, bleach, ammonia, drain cleaner etc.).
17. Do not vacuum hard or sharp objects such as glass, nails, screws, coins, etc.
18. Do not vacuum plaster dust, concrete dust or any other building or vitreous materials.
19. Do not vacuum baking soda or any other powder-based carpet refresher or deodoriser.
20. Do not use the vacuum cleaner with blocked filters or without all of the filters in place.

21. Use only SAA 10 amp extension cords. Non approved cords may overheat. Care should be taken to arrange the cord so that the cord cannot be tripped over.
22. Store the multifunction machine in a cool, dry area.
23. To prevent dirty water from running into motor, do not hold the appliance upside-down or lay on its side. Use appliance in normal vacuuming/carpet washing position.
24. Take extra care when cleaning on stairs.
25. Turn off the on/off switch before unplugging the multifunction machine.
26. Do not carry appliance while motor is running.
27. We recommend the use of a residual current device with a residual current rating of 30mA or less.



**WARNING:** Always switch off and unplug the multifunction machine from the electrical outlet before assembling, opening, emptying the dirt container, before connecting/ disconnecting the attachments, or carrying out maintenance or troubleshooting checks.



**NOTE:** Carpets should be dry vacuumed thoroughly before washing.



**IMPORTANT:** It is very important that filters are kept clean to obtain maximum performance from your vacuum cleaner. Not cleaning and not replacing the filters regularly can reduce the suction power and cause overheating and permanent damage to the vacuum cleaner. If your filters are washable make sure they are completely dry before inserting back into the multifunction machine.



**IMPORTANT:** If the hose or tools are blocked, switch off the multifunction cleaner and remove the blockage(s) before re-starting your machine. See maintenance.

**DAMAGE TO THE VACUUM CLEANER CAUSED AS A DIRECT RESULT OF NOT ADHERING TO THE GENERAL SAFETY INFORMATION AND THE INSTRUCTIONS IN THIS USER GUIDE INVALIDATES THE WARRANTY.**

**This machine is intended for household use only, and NOT for commercial or industrial use.**

**PLEASE KEEP THESE INSTRUCTIONS FOR FURTHER USE.**

# Operation

## Dry Vacuuming

**IMPORTANT:** Always remove the power plug from the wall outlet before assembling, servicing or removing accessories.

**IMPORTANT:** Only the red power button should be "ON" when the machine is in dry vacuuming mode. The green pump button should be "OFF".

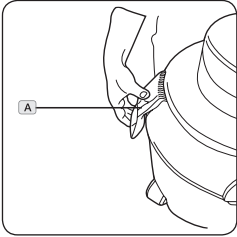

Unclip Container Release Clips (A) on both sides of machine.

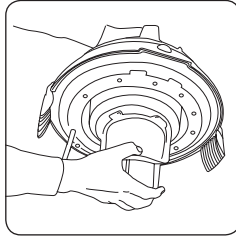

Remove the motor top from the unit, turn on its side and remove the float housing in an anti-clockwise direction to unscrew.

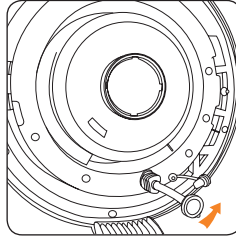

Remove the solution connector tube by turning anti-clockwise by 90 degrees. Store in a safe place.

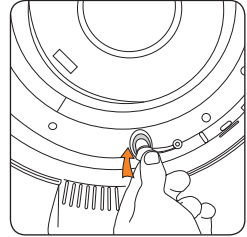

Fit the plug to the solution intake port.

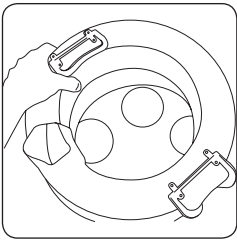

Lift out and remove the clean water solution tank. Store safely away.

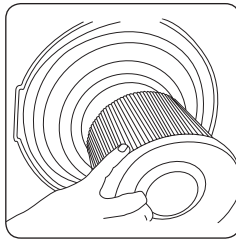

Fit the pleated pre-motor filter by pushing and lightly twisting the filter on the motor top.

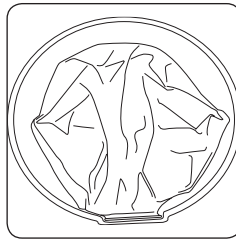

Fit the dust bag by aligning the front of the dust bag with the inlet slots, and position the dust bag to fill the inside of the base.

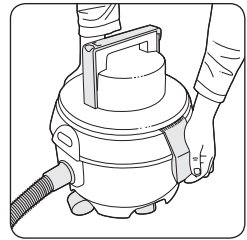

Replace the motor top, ensuring that the dust bag is not trapped. Ensure the motor top is secured to the base with the two clips.

# Operation

## Dry Vacuuming Continued

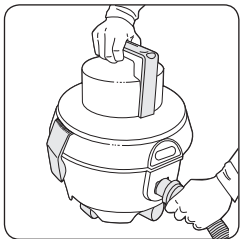

Insert the flexible hose into the inlet on the main body of the vacuum cleaner. Push in and twist clockwise a quarter turn until tight.

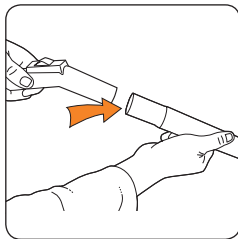

Push the extension tubes onto the end of the handle.

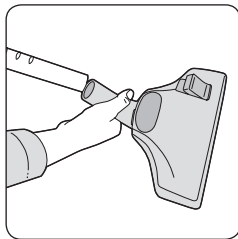

Fit the combination floor tool by pushing on to the extension tube.

## On/Off Button

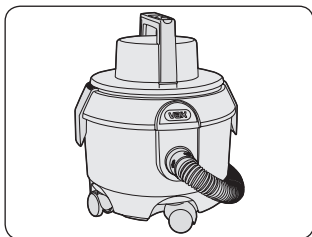

Fully unwind the power cord and plug the cord into the electrical outlet. Turn the vacuum cleaner on by depressing the button located on the top of the carry handle. The vacuum cleaner can be turned off by pressing the on/off button again.

## Carpet Cleaning

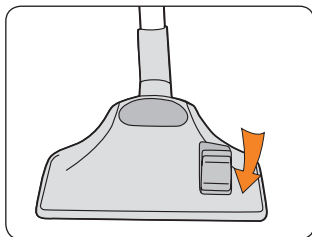

For carpet cleaning, press the rocker switch on the combination floor tool as shown to raise the brushes.

## Hard Floor Cleaning

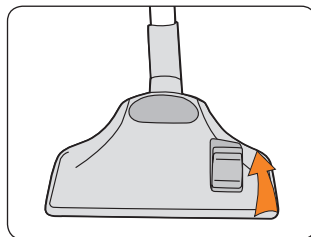

For hard floor cleaning, press the rocker switch on the combination floor tool as shown to lower the brushes.

# Operation

## Accessories

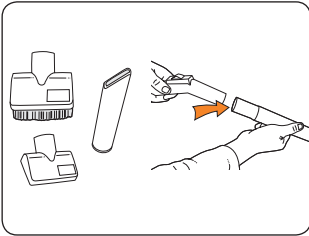

The accessories can be attached directly to the handle by removing the extension tubes and pushing in the desired accessory.

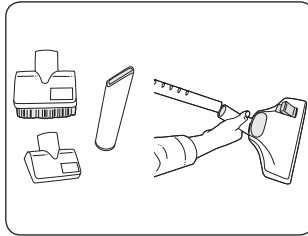

The accessories can also be attached to the extension tubes for extra reach. Remove the combination floor tool and push on the desired accessory.

**Crevice Tool:** for crevices, corners, cracks etc.

**Dusting Brush:** for delicate surfaces.

**Upholstery Tool:** for carpet, upholstery, stairs etc.

# Operation

## Preparing the Carpet for Washing

**IMPORTANT:** Do not use the cleaner as a dry vacuum when set up in carpet washing mode.

1. Dry vacuum carpet thoroughly.
2. Remove as much furniture from the room as possible. If unable to remove the furniture, place plastic or foil under and around the legs until the carpet has dried completely.

### Helpful hints for cleaning carpet:

1. Only use Vax recommended solution with this machine.
2. Do not oversaturate carpet with cleaning solution while using the machine.
3. For heavily soiled areas, additional applications may be necessary.
4. Allow plenty of time to dry carpet thoroughly.
5. Wipe cleaning solution from woodwork to prevent any damage.
6. Try not to walk on carpet until it is completely dry.
7. After carpet is thoroughly dry, vacuum the carpet using a vacuum cleaner with a revolving brushbar. ie. Vax turbo brush.
8. Before cleaning, determine where to start and end, making sure not to walk over previously cleaned areas.

### Check for colourfastness

Before cleaning carpet, test for colourfastness. Dampen a white cloth with solution. Test on a small inconspicuous area prior to washing. Gently rub the cloth over the area. Check each colour for colour bleeding. If the cloth remains clean, it should be safe to clean the carpet.

### After cleaning

- Allow carpet to dry completely. Try not to walk on the carpet until it is dry.
- If it is necessary to walk on the carpet, place white towels on the areas to be walked on.
- If the carpet is not dry and the furniture must be placed back in the room, use plastic or foil under the furniture to prevent staining the carpet.
- Thoroughly clean the dirty water tank with warm (max 40°C) tap water.



# Operation

## Getting Ready to Wash

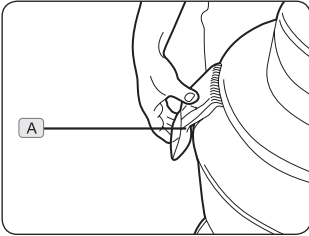

Unclip Container Release Clips (A) on both sides of machine.

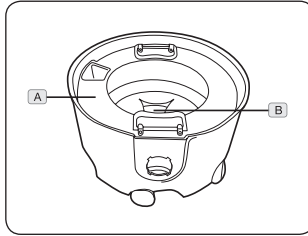

Lift off motor container and remove filter assembly. Remove the plug from the solution intake port and replace the solution connector tube. The machine can be used for washing by placing the clean water tank (A) back inside the dirty water tank (B).

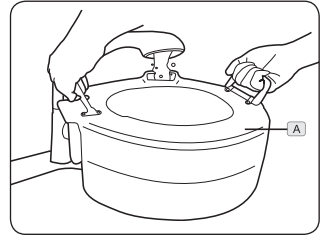

Remove clean water tank (A) from inside the dirty water tank and fill with warm (max 40°C) water to point indicated on the tank. Add 1 capful of Vax Carpet Cleaning solution per litre of water (unless otherwise stated on the bottle).

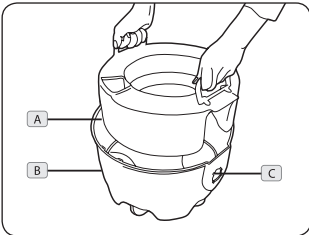

Replace clean water tank (A) inside dirty water tank (B) taking care to ensure that the space to allow the dirty water back into the tank is lined up with the solution port (C).

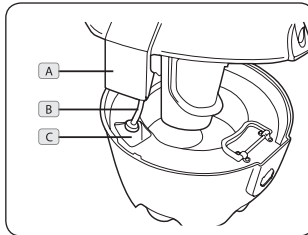

Replace motor container (A) ensuring that the solution pump hose (B) is aligned with the hole in the clean water tank (C) so that it goes inside when the motor container is clipped back into position.

 **WARNING:** Machine must not be plugged in during this stage.

# Operation

## Assembly

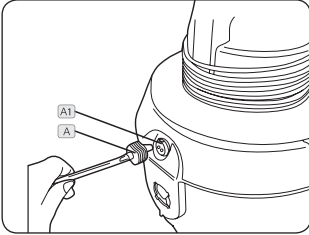

Push solution tube connector (A) firmly into solution port (A1). Twist solution tube connector (A) a quarter turn to the right to lock into place.

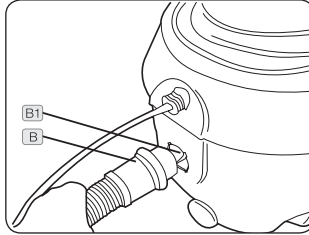

Push hose connector (B) firmly into hose connection port (B1). Twist to the right until hose connector locks into place.

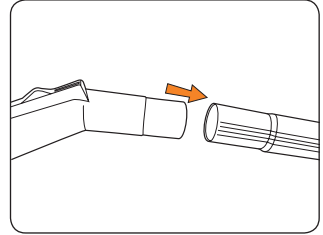

Push one end of the extension tube into the handle of the hose.

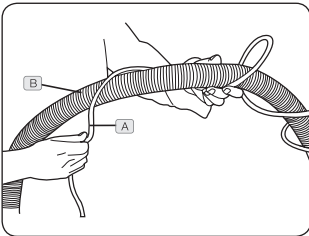

Wrap solution tube (A) around hose (B). Ensure that the solution tube is wrapped loosely enough to allow the solution to flow freely through the tube.

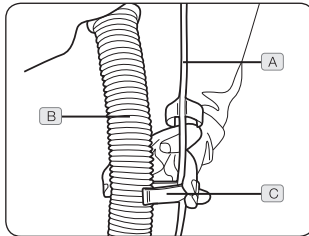

After wrapping the tube around the hose, affix solution tube (A) to hose (B) using clips provided (C) to hold it in place.

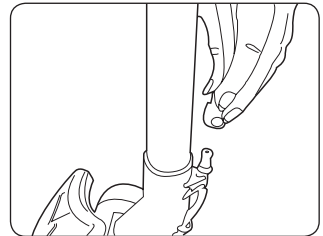

Push the second extension tube into the wash head to be used and push the end of the solution tube onto the connection port on the Wash Head / Upholstery Tool.

# Operation

## Usage

1. Plug in machine to power supply.
2. Press the red button to turn on the power.
3. Press the green button to activate the pump.

## Washing Carpets

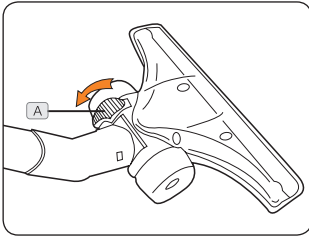

1. On the Fibreflow wash head ensure that the rocker switch (A) is towards the back of the head to allow water to flow through the head.

2. With the solution flowing, wash a section of carpet approx. 3 metres x 3 metres by pushing the wash head backwards and forwards over the area.

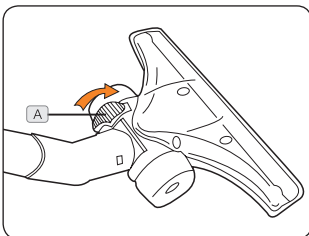

3. Stop the solution flow by moving the rocker switch (A) to the forward position on the Fibreflow wash head. This will prevent water flow, allowing excess water to be removed from the section just washed.

4. To wash the next section of carpet, repeat steps 1 to 3. Continue until the area is washed.
5. When clean water reservoir is empty, solution will stop flowing through the wash head and the pump will make a 'sound' due to sucking air. Refill the water reservoir with clean water and Vax Carpet Cleaner. Be sure to empty the dirty water recovery bucket at this time.
6. If the dirty water recovery bucket becomes full, the 'sound' your Vax makes will change and suction will drop. Time to empty it! Failure to do so will activate the float which, with continued use, will cause the machine to overheat.

# Operation

## Washing Upholstery

1. Detach wash head from the solution tube and extension tubes.
2. Pull the extension tube out of the handle of the hose.

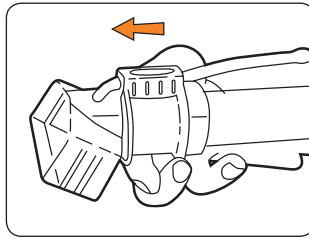
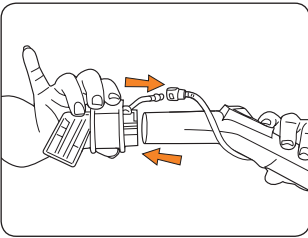

3. Attach the upholstery wash tool directly onto the handle of the hose and wrap the excess solution tube around as necessary.
4. To start water and solution flow, push the collar on the wash tool forwards.
5. When you see water swirling in the washing tool you are ready to start washing.
6. Pull the washing tool backwards. You are now washing the upholstery. Cover a small area at a time. Don't push the tool backwards and forwards as this may stretch the fabric.

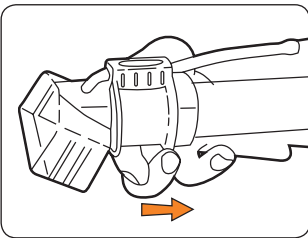

7. Stop the washing solution flowing. To stop the flow, pull the black collar on the wash tool backward.
8. Move to next area and repeat steps 4 to 7.

# Maintenance (Keep your Vax as good as new)

## Dust Bag and Filters: Removal and Replacement

 **IMPORTANT:** Always unplug the machine from the electrical output before removing the dust bag.

 **IMPORTANT:** Do NOT use the vacuum cleaner in dry mode without ALL of the filters in place.

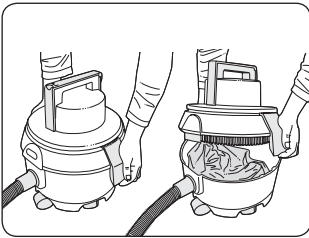

Turn off the vacuum cleaner and unplug it from the mains. Remove the hose. Unclip the retainer clips on either side of the vacuum cleaner and lift off to gain access to the dust bag compartment.

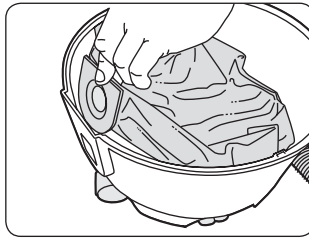

Lift out the full dust bag.

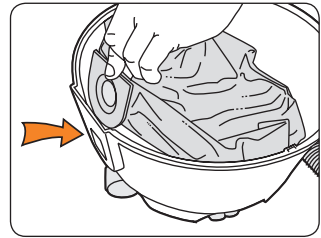

Dispose of the full dust bag and insert a new dust bag back into the vacuum cleaner aligning the front of the dust bag with the inlet slots.

# Maintenance (Keep your Vax as good as new)

 **IMPORTANT:** Ensure that the machine is switched off and unplugged from the socket before carrying out any maintenance.

## Cleaning the Pre-Motor Filter

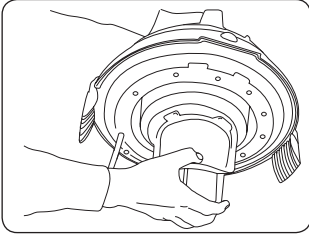

Remove the motor top from the unit, turn on its side and remove the float housing in an anti-clockwise direction to unscrew.

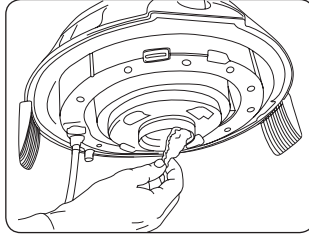

Remove the blue filter and wash under a tap. Allow to dry thoroughly before replacing back into the machine. Replace with a new filter as necessary.

Turn the float housing in a clockwise direction until secure and place the motor top back onto the unit.

## Cleaning the Pleated Pre-Motor Filter Assembly

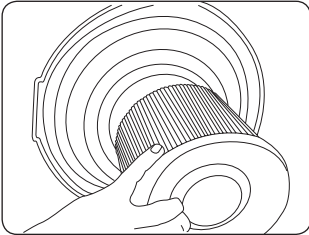

Remove the filter by twisting gently. This will release it from the motor housing.

Clean by tapping it against the side of a bin or by brushing gently.

**NOTE:** Do not wash this filter.

# Maintenance (Keep your Vax as good as new)

## Cleaning the Post-Motor Filter

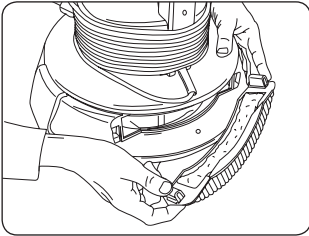

Remove the filter housing at the back of the machine.

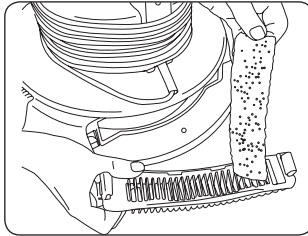

Remove the filter and wash under a tap. Allow to dry thoroughly before replacing back into the machine.

Once dry, put the filter back into the housing and place back into the machine.



**IMPORTANT:** Even with regular cleaning, filters have a limited lifespan and will eventually need to be replaced during the lifetime of the vacuum cleaner. If the performance of your vacuum cleaner is compromised and/or the filters are severely discoloured, the filters may need to be replaced. As a general guide, Vax recommends filters are replaced every 3-6 months depending on the level of use to ensure optimum performance of your vacuum cleaner.

# FAQ's



**WARNING:** To reduce the risk of personal injury, unplug the cleaner before performing maintenance/troubleshooting checks.

Problem	Cause	Solution
Cleaner won't run	Not properly plugged into electrical outlet.	Plug in firmly.
	No electricity in electrical outlet.	Check fuse or breaker.
	On/off switch not turned on.	Push on/off switch to 'on'.
	Blown fuse/tripped breaker.	Reset circuit breaker or replace fuse.
Cleaner won't pick up/loss of suction	Dust bag not installed correctly.	Review dust bag removal and replacement.
	Dust bag full or blocked.	Replace dust bag.
	Clogged filter.	Remove filter and clean.
	Blockage in hose.	Disconnect hose, remove the obstruction then re-fit.
Cleaner/accessories won't pick up	Accessories not connected properly.	Refer to page 6 for fitting information.
	The hose is clogged.	Remove hose and tools. Remove obstruction.

## we're here to help

Instead of taking me back to the shop, simply call:

**AU: 1300 361 505**

**NZ: 0800 800 900**

[vax.com.au](http://vax.com.au)

This does not affect your statutory rights



# Other Information

## Vax Service & Help

### Vax Careline:

Australia 1300 361 505

New Zealand 0800 800 900

Monday-Friday 8.30am to 5.00pm

If you have queries or concerns about using your Vax, call the Vax Careline. Calls are charged at the standard local rate. Please make a note of the serial number and model number of the vacuum cleaner before calling.

For the nearest Service Agent, please call the Vax Customer Careline or visit [vax.com.au](http://vax.com.au)

## Technical Specification

Model Number 30000

Voltage: 220-240V ~50Hz

Wattage: 1300W

Capacity: Clean water tank: 4 Litres  
Dirty water tank: 5.2 Litres

Cord length: 7.5m

Weight: 12.5kg

Subject to technical change without notice.



Double Insulated



Indoor Use



Read Instructions



Waste electrical products should not be disposed of with household waste. Please recycle where facilities exist. Check with your Local Authority or retailer for recycling advice.

# Notes



# Notes





**Performance is everything.™**

Distributed by Techtronic Industries Australia Pty. Ltd.  
Level 1, 660 Doncaster Road, Doncaster, Australia 3108.  
[www.vax.com.au](http://www.vax.com.au) Service Line: AU: 1300 361 505 / NZ: 0800 800 900