



**'DON'T TAKE IT
BACK TO THE SHOP!'**

Congratulations on the purchase of this Vax product. In the unlikely event of experiencing a problem, call

VAXCARE



Australia **1300 36 4040**

(Monday - Friday 10am - 6pm EST)

Email: **vaxcare@vax.com.au**

New Zealand **0800 800 900**

Email: **vaxnz@vax.co.nz**

www.vax.com.au



www.vax.com.au

**Vaxcare:
AUST: 1300 36 4040
NZ: 0800 800 900**

Multifunction Instruction Manual

FOR QUICK AND EASY USE OF YOUR **vax**

**VAXCARE Service & Help:
AUSTRALIA 1300 36 4040
NEW ZEALAND 0800 800 900**

If you have any queries or concerns about using your Vax, call VAXCARE.

Please make a note of the part number or model number of the appliance before calling.

(Aust only: Mon-Fri. 10.00am to 6.00pm. EST)

Calls are charged at the local rate.

An answerphone is available out of these hours.

There are over 300 approved Vax Service Agents in Australia and New Zealand. For the nearest Service Agent, please refer to your Vax warranty or call VAXCARE or visit www.vax.com.au

Technical Specification

Weight: Net 8.0Kg
Size: Height 54cms x 34cms diameter
Motor: 1200 watts max. / 450 watts min variable power. 2 stage bypass motor completely insulated and sealed against water contamination.

Structure: Moulded high-impact resistant ABS

Dust Bags: Supplied with machine.

Clean Water

Reservoir: 4 litres of clean water.

Recovery

Bucket: 8 litre capacity.

Hose: 1.8m long, crush resistant hose with 360 (degree) swivels at each end.

Subject to technical change without notice.

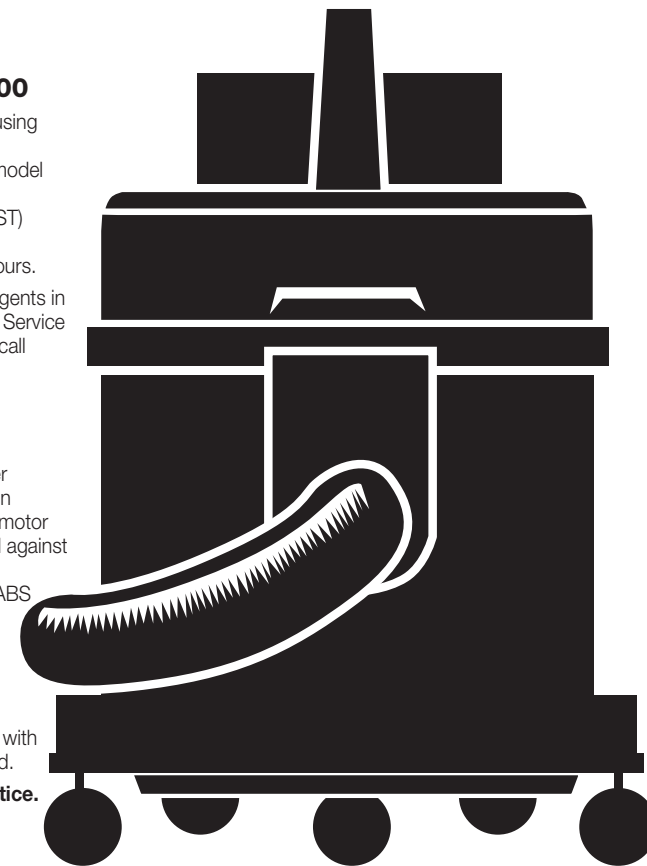

Model No. V2000 - Sukka - VHN - Pet VAX - Family VAX

Instruction Manual

Please read carefully before using this cleaner.
Always fully extend the mains cable before use.
Retain for future reference.

1. Important Safety Information

THIS 'EASY GUIDE' SHOULD BE READ COMPLETELY AND REFERRED TO AT ALL TIMES BEFORE USING YOUR VAX.

This 'easy guide' should be retained with your VAX for future reference.

If your VAX is sold or transferred to a new owner, this guide should be passed on so that the new owner can become acquainted with the machine and this information. The following information is provided in the interest of safety.

Please read it before using your VAX.

DO'S

- Use only genuine VAX replacement parts.
- Use of non VAX fluids, filters and accessories may damage your machine and void your warranty.
- Ensure the mains cable is fully unwound and straightened before use.
- If the supply cord is damaged, it must be replaced by the manufacturer or its service agent or a similarly qualified person in order to avoid a hazard.
- Ensure the mains cable is kept well away from the revolving brushes (where fitted) of your VAX, when it is turned on and running.
- Keep the mains cable away from heat, oil, sharp edges and rough surfaces and avoid damage in any other way.
- Exercise extreme care when cleaning stair carpets. Ensure that your VAX is in a stable position at either the top or bottom of the stairs without over-stretching the hose or cable. When cleaning the stair treads, always keep a hand firmly on your VAX. You may prefer to remove the castors.
- Follow the instructions in this user guide when fitting accessories or tools.
- Remove the plug from the wall socket before carrying out any maintenance specified in this guide.
- Change dust bag and filters at regular intervals.
- Store your VAX in a dry place.
- Have your VAX serviced by an authorised VAX Service Agent only using genuine VAX spare parts.

DONT'S

- This appliance is not intended for use by young or infirm persons unless they have been adequately supervised by a responsible person to ensure that they can use the appliance safely. Young children should be supervised to ensure that they do not play with the appliance.
- Never drag your VAX by the mains cable.
- Never tug at the mains cable to remove the plug from the wall socket.
- Never allow the complete coiled mains cable to drop on the floor as this may result in kinks or knots occurring in the cable, causing premature failure.
- Don't let anyone touch the rotating brush bar (where fitted) unless your VAX is disconnected from the mains.
- Never use your VAX in the presence of flammable gases.
- Avoid sucking up hot items, hazardous liquids or any other material which could damage your VAX.
- Never leave your VAX running unattended.
- Never use your VAX without a dust bag.
- If your VAX fails to operate, never attempt to repair it yourself as repairs carried out by an unauthorised or inexperienced person may cause injury to you or damage to your VAX and void your warranty.
- Never alter the specification or modify your VAX in any way.

EXTENSION CABLE

If using an extension cable always ensure that the insulation sheath is in good condition and is not damaged in any way.

Make sure that the plug and socket are fitted to the extension cable correctly, if in doubt have it checked by a qualified electrician.

Always use the extension cable in accordance with the manufacturer's instructions.

IMPORTANT: When carrying out any maintenance or cleaning operations on this product, it is essential that the plug is removed from the wall socket.

In the interests of product improvement, the Company reserves the right to introduce modifications or alterations without notice.

- The Sock Filter that encases the HEPA filter, acts as a pre-filter and protects it from the majority of dust.

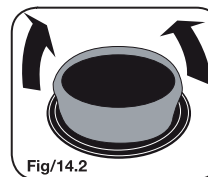

Fig/14.2

To clean the Sock Filter gently peel it back from the HEPA (Fig/14.2).

Shake to remove the excess dirt and hand wash at normal temperature. Do not machine wash or tumble dry. Do not replace the sock when it is still damp or wet.

When replacing the Sock Filter on the HEPA ensure that the sock is pulled down completely all round.

The Sock Filter can be cleaned up to 5 times in this way and should then be replaced.

- With the sock removed, the HEPA Filter can be cleaned by gently tapping on a hard surface. The HEPA Filter should never be washed or exposed to water. VAX recommends that the HEPA Filter be replaced every 12 months to maintain peak performance.

TIP

The HEPA filter can also be cleaned by taking the vacuum outside, removing the HEPA and vacuuming the HEPA only with the dusting tool. Ensure all filters are replaced before vacuuming your home.

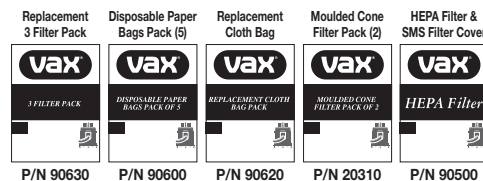

15. Removing debris from the Mini TurboTool

(Model: Pet VAX only. Optional with other models.)

- Switch the vacuum cleaner off and disconnect the power plug from the electrical outlet. Rotate or remove the locking ring (Fig/15.1).

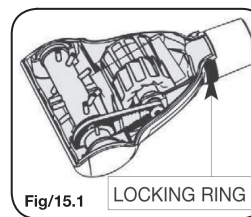

Fig/15.1

LOCKING RING

- Lift the top cover off and remove any debris (Fig/15.2).

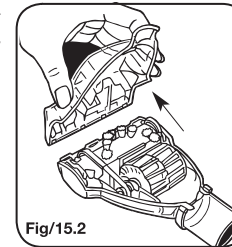

Fig/15.2

- To re-assemble, ensure that the tabs are engaged. Pivot the lower housing closed and rotate or replace the locking ring 180° (Fig/15.3).

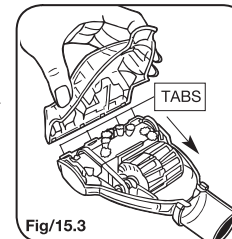

Fig/15.3

16. Removing hair from TurboBrush

(Model: Pet VAX & Family VAX or optional extra with other models).

Over time hair and lint will build up around the brushbar. This must be removed to maintain performance and prevent damage to the tool.

- Switch the vacuum cleaner off and disconnect the power plug from the electrical outlet.
- Turn the brushbar over and using a pair of scissors run the bottom blade along the length of the brushbar cutting the hair as you go (Fig/16.1).

USE SCISSORS WITH THE POINT OF THE BLADE AWAY FROM YOUR BODY.

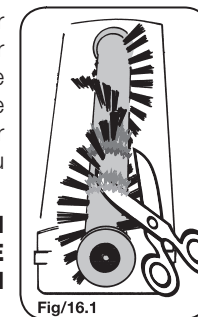

Fig/16.1

- Once the hair and lint around the brush bar has been cut, remove the hair out of the brushes.

17. Storage

IMPORTANT: Always unplug the vacuum cleaner from the electrical outlet and rewind the power cord as directed before storing.

NOTE: Always store the vacuum cleaner base down.

12. If You Have Washing Difficulties

IF YOU HAVE WASHING DIFFICULTIES, CHECK...

1. The pump washing button is switched on.
2. The tube valve is properly connected (Fig/12.1).

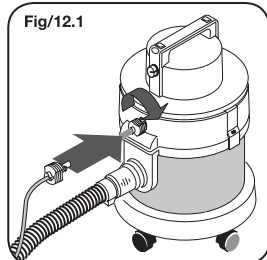

3. The weight on the end of the solution tube is at the bottom of the water reservoir and not trapped between the motor and water reservoir (Fig/12.2).

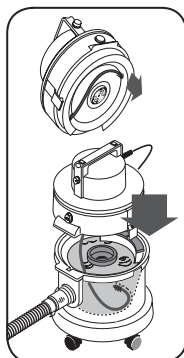

4. The rocker switch is positioned towards the back (Fig/12.3).

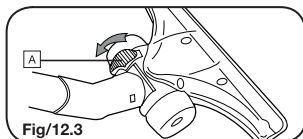

5. The washing tool is flat on the surface being washed.
6. The power control is correctly adjusted within the washing range. Turn higher than minimum wash setting for uneven or higher pile if required (Fig/12.4).



7. There are no kinks in the solution tube. Remove kinks by rubbing the tube between finger & thumb
8. That the recovery bucket is not full, causing the automatic cut off valve to stop the suction.

13. Looking After Your VAX

Items below are available from your Vax Retailer or from VAX direct.

REGULARLY (when you buy a new pack of 5 disposable paper bags or 1 new cloth bag)...

Replace cone filter

Available in a pack of two. Also available with a bondini filter and exhaust filter in a 3 filter pack.

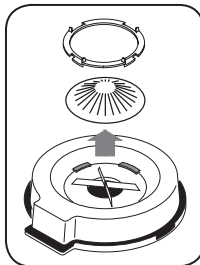

Clean the Bondini filter

Available with a cone filter and exhaust filter in a 3 filter pack. Wash filter in warm water. Squeeze it dry and replace. Your VAX will work more efficiently if the Bondini filter is replaced with a new one occasionally.

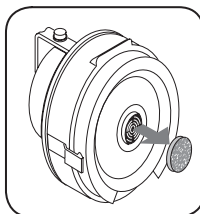

Clean the exhaust filter

Available with a cone filter and bondini filter in a 3 filter pack. Wash filter in warm water. Squeeze dry and replace.

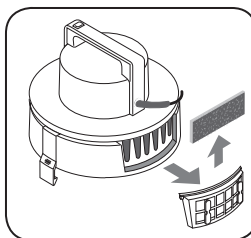

14. Looking After Your HEPA Filter (Model Family VAX and Sukka only. Optional extra with other models. Contact VAXCARE for information)

1. Remove the HEPA Filter by turning anticlockwise (Fig/14.1).

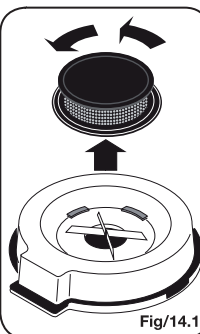

2. Parts Checklist

Before using your VAX, please read 'Important safety information' on page 2.

All VAX Multifunctions include:

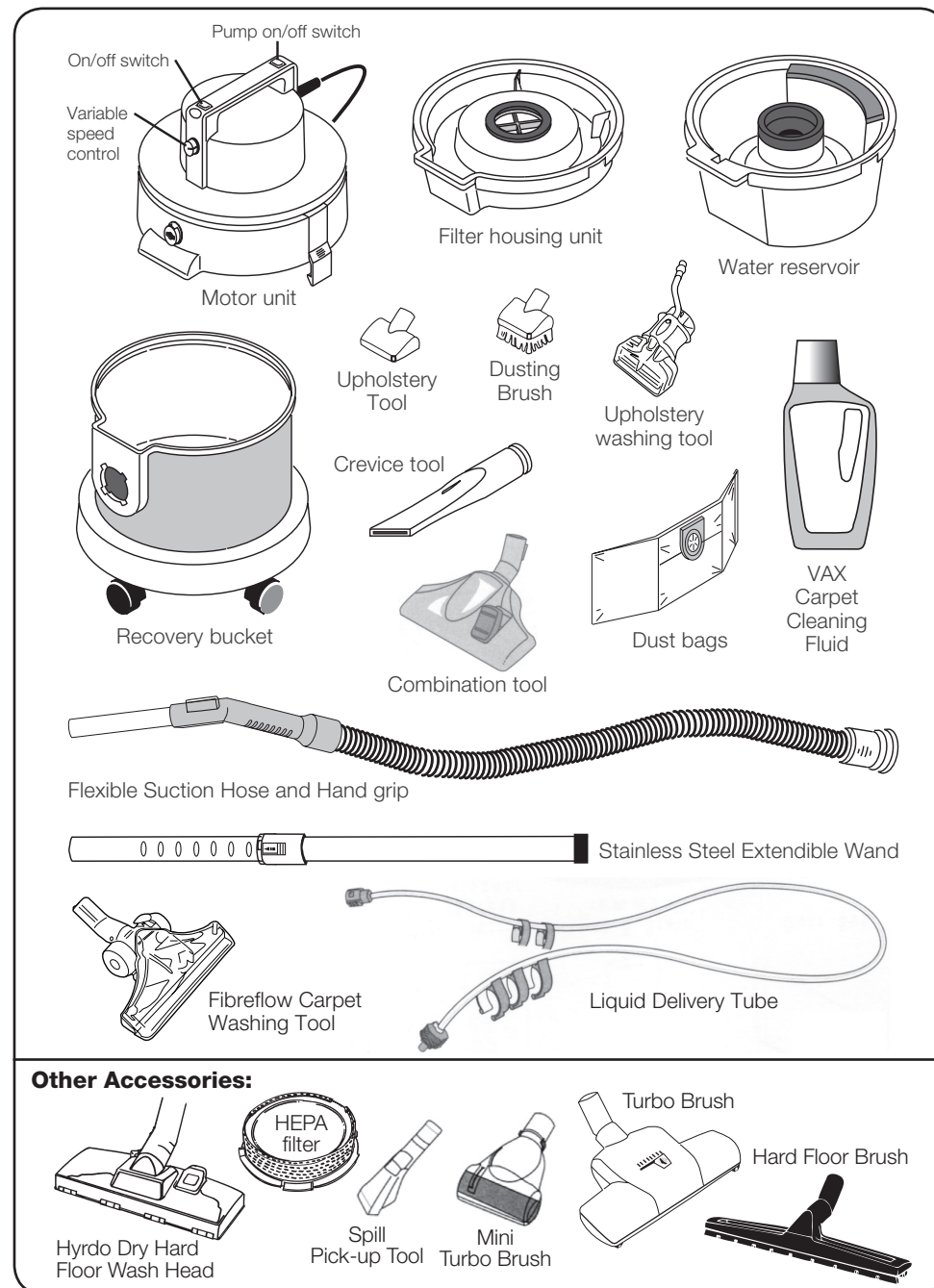

Other Accessories:

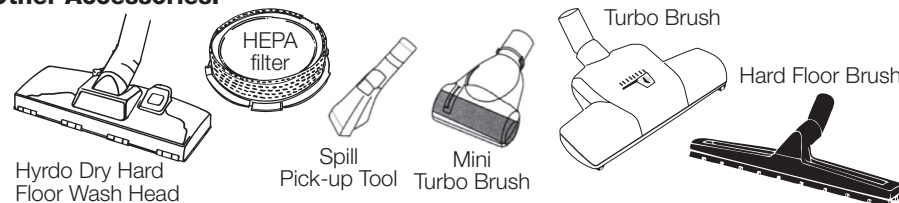

3. Dry Vacuuming

1. Fit a dust bag by pushing it firmly into the recovery bucket before connecting hose (Fig/3.1).

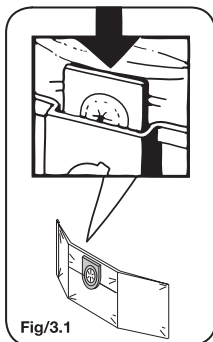

2. Push the connector on the end of the hose. Turn it clockwise to lock (Fig/3.2).

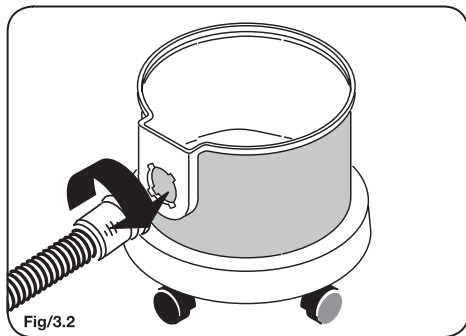

3. Fit the filter housing and motor to the recovery bucket. Ensure the two retaining clips are secured. You may have to push down hard on the edges of the motor unit above the clips. They are a tight fit (Fig/3.3).

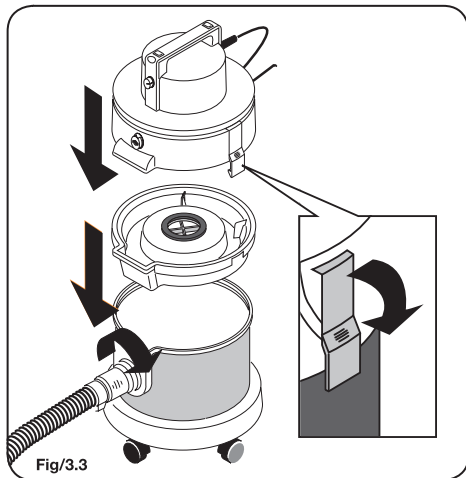

4. Fit the extendible wand to the hose hand grip. Adjust wand length by pressing button in the direction of the arrow (Fig/3.4).

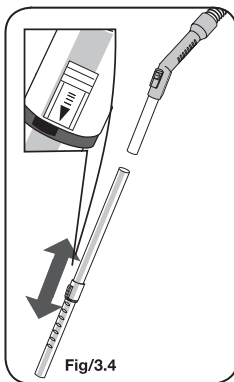

5. Choose suction power by turning the dial located at the front of the motor. Vacuum carpets on high power. Vacuum fabrics and upholstery on low power.
6. Choose the right tool for the job. The smaller tools can be fitted to the back of your VAX when not in use.
7. Switch on and begin vacuuming.

TIP

- As your VAX is very powerful, you may find that the dust bag fills up quickly the first time you use it.
- Should a blockage occur in the suction hose/hand grip it can usually be “unblocked” by reversing the hose and running the machine for a few seconds or so. It may be necessary to bind the hand grip end of the hose with a cloth to form a temporary seal between the hand grip and the connector socket on the recovery bucket.

Upholstery Tool: For use on carpet, upholstery, stairs etc

Dusting Brush: For cleaning delicate surfaces.

Crevice Tool: For cleaning in narrow gaps.

Mini Turbo Brush: Rotating Brush Bar dislodges hair and lint from upholstery (Model: Pet VAX only).

Combination Tool: Use the lever to switch between vacuuming hard floors and carpets.

Turbo Brush: Rotating Brush Bar dislodges hair and lint from carpets (Model: Pet VAX and Family VAX only).

Spill Pick-up Tool: Takes up small liquid spills (Model: Pet VAX only).

For information on accessories contact VAXCARE.

9. What to Do After Washing

AFTER WASHING - ALWAYS...

Keep your VAX assembled. Clean the washing tool, stainless steel wand and hose, by sucking up some clean warm water. After sucking up the water, leave your VAX switched on. Air flowing through the hose will help dry it out.

AFTER WASHING

Clean out the washing tools to prevent dirt and residue from drying out (Fig/9.1)

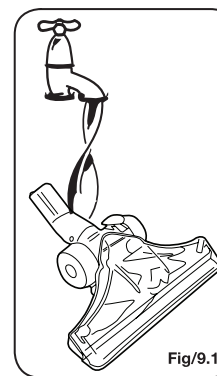

10. How to Unblock Sinks

1. Set up for washing, but don't connect the extendible wand, solution tube or put water in the water reservoir. If the water in your sink is soapy, VAX Defoamer will be required in the recovery bucket.

2. Wrap a cloth around the bent end tube to create a seal between the tube and the plug hole (Fig/10.1).

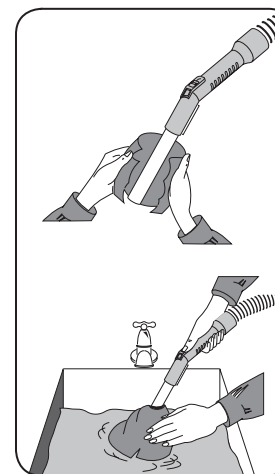

3. Turn the suction power to maximum and switch on. The 'sound' your VAX makes will change and the suction will drop when the recovery bucket is full. Time to empty it!

11. How to Suck Up Large Spills

If your washing machine floods or the deep freeze has been defrosted, leaving pools of water about, your VAX can help.

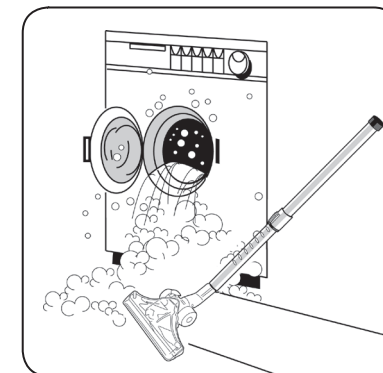

1. Set up for washing, but don't connect the solution tube or put water in the water reservoir (Fig/11.1).

If the spill is soapy, VAX Defoamer will be required in the recovery bucket. Refer to instructions on Defoamer bottle.

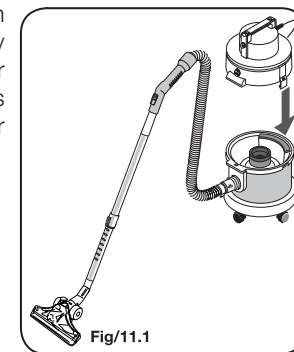

2. Use the metal extension tube or extendible wand or connect the washing tool directly to the hand grip.
3. Turn the suction power to maximum and switch on (Fig/11.2).

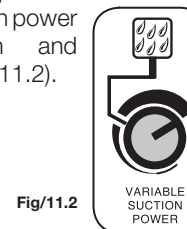

4. Suck up the spill. The 'sound' your VAX makes will change and the suction will drop when the recovery bucket is full. Time to empty it!

- To stop the solution flow, pull the collar on the wash tool backward. Go back over the area you have just washed. This will remove excess moisture from the upholstery (Fig/7.3).

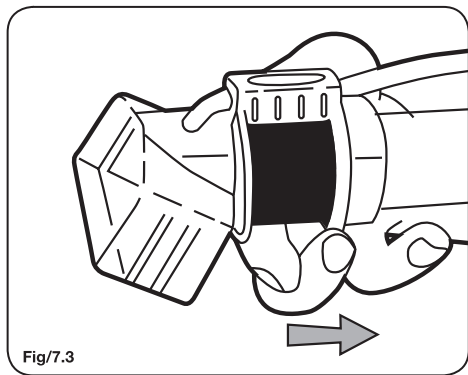

Fig/7.3

- Move to the next area and repeat steps 6 to 9.
- When no more water reaches the wash tool the pump will make a 'sound' due to sucking air. Refill the water reservoir with water and VAX Carpet cleaner. Empty the recovery bucket when you refill the water reservoir. The 'sound' your VAX makes will change and the suction will drop if the recovery bucket is full. Time to empty it!

Tip

- Use the upholstery washing tool for spot cleaning small patches on either carpet or upholstery.

8. How to Wash Hard Floors

(Model Family VAX only. Optional with other models.)

- Set up your Vax as described on page 5 changing the carpet cleaning solution for hard floor solution.
- Connect the Hydro-dry hard floor wash head to the end of the extendible wand and fit the solution tube to the Hydro-dry head.
- Switch the power button ON.
- Turn suction power to wash setting.
- Start the washing solution flowing. To start the solution flow through the wash head, push down the rocker switch on the Hydro dry head so that the switch is pushed towards you (Fig/8.1).

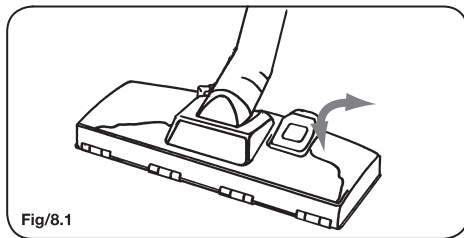

Fig/8.1

This also lowers the sponge and brushes to scrub the floor surface (Fig/8.2).

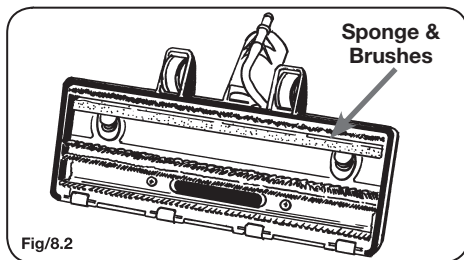

Fig/8.2

- Glide the Hydro-dry head back and forth over the floor surface. Wash an area of around 3 square metres.
- To stop the washing solution flow, push the rocker switch forward. This will also raise the sponge and brushes exposing rubber blades.
- Turn the suction power to maximum.
- Continue to move the Hydro-dry head over the floor surface to pick up excess water.
- Move to the next area and repeat steps 3 to 9.

4. How to Use the Spill Pick-up Tool

(Model Pet VAX only. Optional with other models. Contact VAXCARE for information)

The Spill-pick up tool can be used while dry vacuuming to pick up small liquid spills.

- Attach the spill pick-up tool to the vacuuming hose. Turn your VAX on. Suck up the spill keeping the spill pick-up facing down. Do not overfill above the max level mark (Fig/4.1).

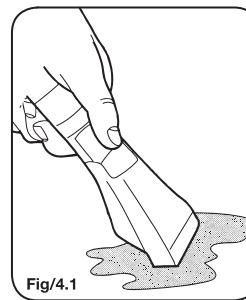

Fig/4.1

NOTE: Do not tip the tool upside down or the fluid will leak out.

- Remove the spill pick-up from the hose. Release the connector by pushing the black release button and pull to disconnect. Dispose the spill (Fig/4.2).

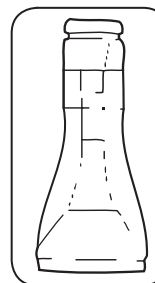

Fig/4.2

- Separate the parts and rinse. Dry components before replacing (Fig/4.3).

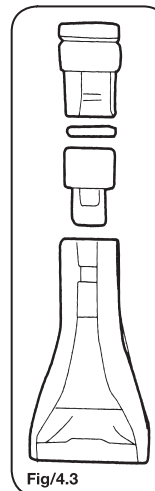

Fig/4.3

NOTE

- The spill pick-up is designed to pick-up fluid. Any staining or marking can be washed using your VAX fitted with the appropriate washing tool.

5. Getting Ready to Wash

3 ITEMS OUT

Filter housing unit

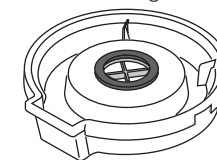

Dust bag



Vacuuming tool



3 ITEMS IN

Water reservoir with water and carpet cleaner

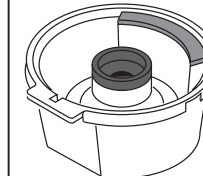

Liquid delivery tube



Washing tool



- Vacuum the area you intend to wash.
- Remove the motor filter housing, hose, dust bag and vacuuming tool.
- When dust bag is removed, re-fit the hose. Push and turn clockwise (Fig/5.1).

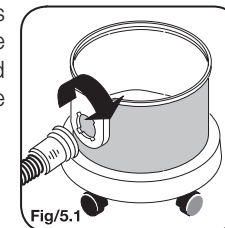

Fig/5.1

- Fill the water reservoir with warm water (not hot), to the level marked on it. Fit the water reservoir into the recovery bucket (Fig/5.2).
- Add VAX Carpet Cleaner to the clean water. Refer to the instructions on the carpet cleaner bottle.

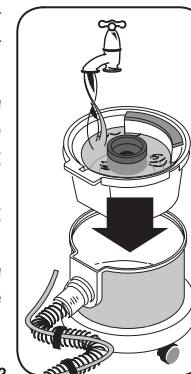

Fig/5.2

6. Wrap Solution Tube (A) to Hose (B) using Clips provided (C) to hold it in place. Ensure that the solution tube is wrapped loosely enough to allow the solution to flow freely through the tube (Fig/5.3).

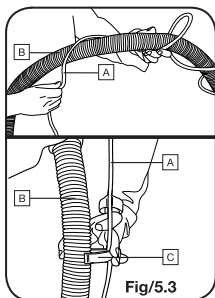

7. Fit the extendible wand to the suction hose.

8. Fit the washing tool and push end of Solution Tube onto connecting valve on the Carpet/Upholstery Wash Tool (Fig/5.4).

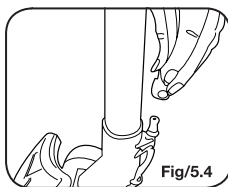

TIP

To achieve correct length lay tube with clips parallel to hose and wand before attaching.

9. Unclip the transparent tube on the bottom of the motor unit. Ensure the tube is positioned at the bottom of the washing solution (Fig/5.5).

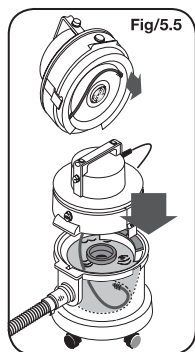

10. Fit the motor unit (make sure the transparent tube is not trapped when you do this) Secure clips on both side of motor.

11. Locate the tube valve, push in firmly and turn clockwise (Fig/5.6).

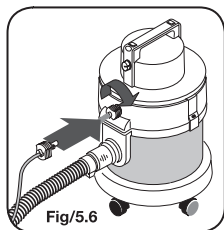

YOU ARE NOW READY TO START WASHING

TIP

If your carpet has been previously washed with a high foaming shampoo, pour VAX Defoamer into the recovery bucket. VAX Defoamer is available through your VAX Stockist.

6. How to Wash Carpets

1. Set up your VAX as described on page 5.
2. Switch ON.
3. Switch on the power washing button.
4. Turn the suction power to the wash setting or higher, depending on the carpet pile (Fig/6.1).

Fig/6.1



5. To allow water to flow through the Fibreflow wash head, ensure that the rocker switch (A) is positioned towards the back of the wash head (Fig/6.2).

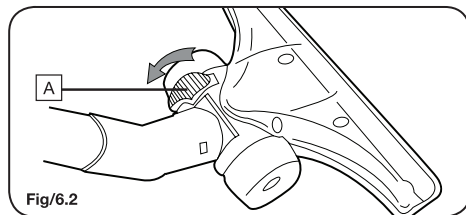

6. With the solution flowing, wash a section of carpet approx 3 metres x 3 metres by pushing the wash head backwards and forwards over the area.
7. Stop the solution flow by moving the rocker switch (A) to the forward position on the Fibreflow wash head. This will prevent water flow, allowing excess water to be removed from the section just washed (Fig/6.3).

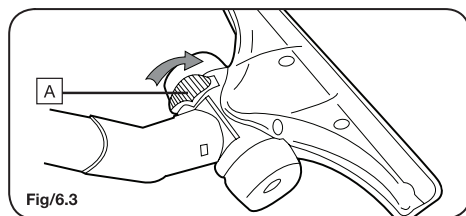

8. Turn the pump washing button off and turn the suction power to maximum. Go back over the area you have just washed. This will now extract excess moisture from the carpet.

9. Move to the next area and repeat steps 3 to 8.

10. When no more water reaches the wash tool the pump will make a 'sound' due to sucking air.

Refill the water reservoir with water and VAX Carpet cleaner. Empty the recovery bucket when you refill the water reservoir. The 'sound' your VAX makes will change and the suction will drop if the recovery bucket is over-full. Time to empty it! (Fig/6.4)

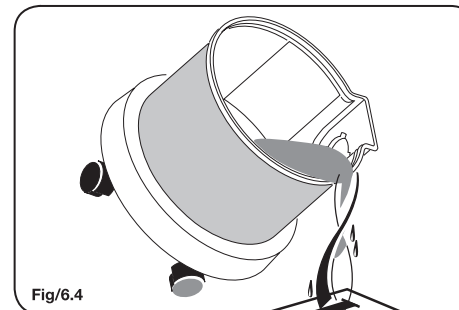

Fig/6.4

Tip

• **ALWAYS TEST FOR COLOUR FASTNESS WITH SOME UNDILUTED CARPET CLEANER ON A HIDDEN AREA FIRST.**

- Start from the corner of a room and work backwards towards the door.
- If you are washing very dirty carpets, you may have to wash them several times over a period of time to bring all the dirt to the surface.
- When washing stairs, place your VAX above the area you are washing. **ALWAYS ENSURE YOUR VAX IS STABLE.** The castors on your VAX will pull off, giving it extra stability on stairs or slopes. **DO NOT PULL EXCESSIVELY ON THE HOSE.**
- Metal or wooden furniture legs may mark a wet carpet. Wait until the carpet is dry or place aluminium foil under the feet of furniture.
- When washing deep pile carpets, move the washing tool in the same direction as the pile lays.
- Don't allow children or animals onto the carpet until it is dry.

7. How to Wash Upholstery

1. Set up your VAX as described on page 5, BUT don't use the extendible metal wand.
2. Connect the upholstery washing tool to the short bent end and wind the excess solution tube around a portion of the hand grip. Connect the tube to the upholstery washing tool (Fig/7.1).

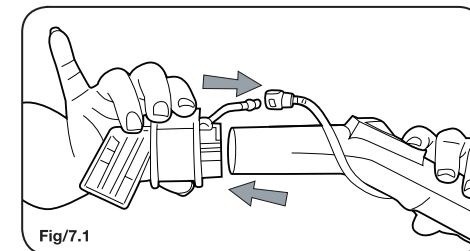

Fig/7.1

3. Switch power button ON.
4. Switch ON the pump washing button.
5. Turn the suction power to the wash setting.
6. To start the solution flow, push the collar on the wash tool forward (Fig/7.2).

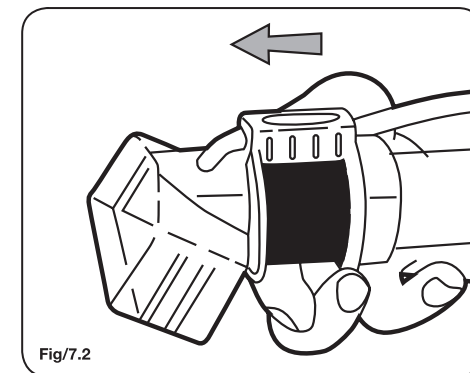

Fig/7.2

7. When you see water swirling in the washing tool you are ready to start washing.
8. Draw the washing tool backwards across the upholstery. Cover a small area at a time. Don't push the tool backwards and forwards as this may stretch the fabric.