

Vax Service line
AU: 1300 361 505 / NZ: 0800 800 900

Machine Overview

- 1 Hose connector
- 2 Dirt container
- 3 Cyclone separator and shroud
- 4 Dirt disposal button (hidden)
- 5 Carry handle
- 6 Dirt container release button
- 7 On/off button
- 8 Variable power dial
- 9 Floor head parking slot
- 10 Cord rewind button
- 11 Wheel
- 12 Pre-motor filter
- 13 HEPA H12 post-motor filter/
HEPA H12 antibacterial post-motor filter
(some models only)
- 14 Dusting brush
- 15 Crevice tool
- 16 Upholstery tool
- 17 Hose and handle
- 18 TurboTool (some models only)
- 19 Extension tube and tool caddy
- 20 Stretch hose (some models only)
- 21 Combination floor head (some models only)
- 22 Turbobrush (some models only)
- 23 Hard floor tool (some models only)
- 24 TurboTool connector (some models only)

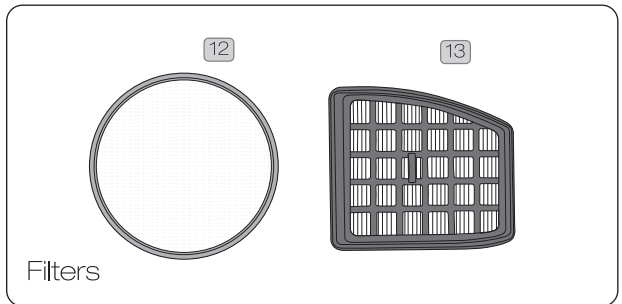
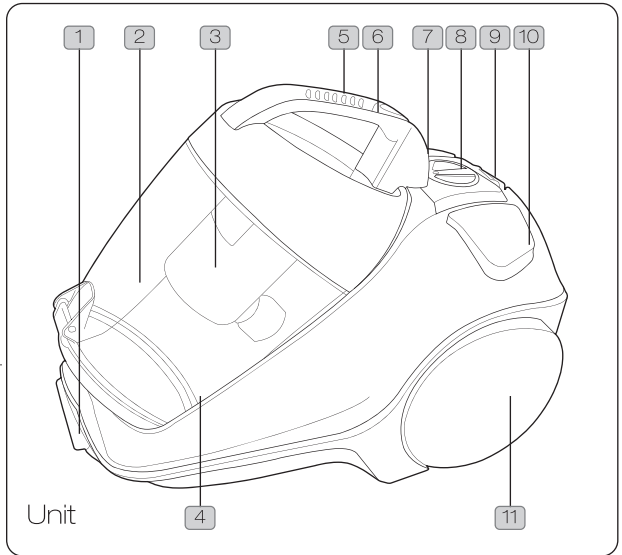

PLEASE NOTE: some parts may vary according to model. Please check inside flap of box for more details.

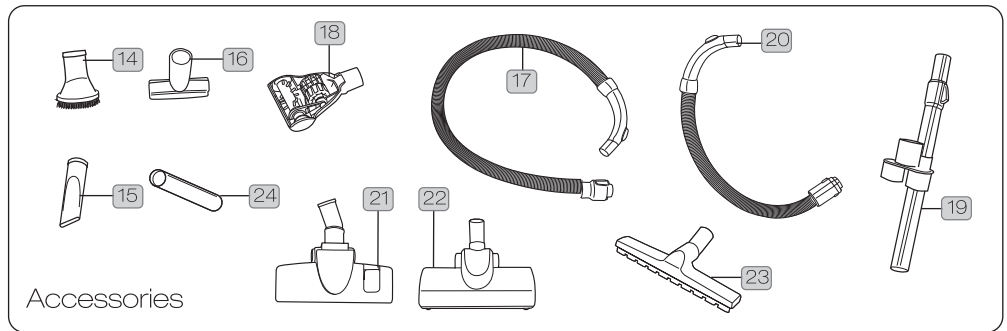

General Safety Information

FOR HOUSEHOLD USE ONLY.

When using the hard floor cleaner, basic safety precautions should always be observed, including the following:

1. Only use the vacuum cleaner indoors on dry surfaces. Do not handle the plug or vacuum cleaner with wet hands. Do not use outdoors or on wet surfaces.
2. Turn off the vacuum cleaner controls before disconnecting or connecting from the mains supply.
3. Always unplug the vacuum cleaner before connecting or disconnecting the vacuum hose and accessories.
4. Children should be supervised to ensure that they do not play with the appliance.
5. This appliance is not intended for use by persons (including children) with reduced physical, sensory or mental capabilities, or lack of experience and knowledge, unless they have been given supervision or instruction concerning use of the appliance by a person responsible for their safety.
6. Use only as described in this manual. Use only Vax recommended attachments.
7. Do not use the vacuum cleaner if it has been dropped, damaged, left outdoors or dropped into water. Do not use the vacuum cleaner with a damaged cord or plug. If the supply cord is damaged, it must be replaced by the manufacturer or a recommended Service Agent to avoid hazard and invalidating the guarantee.
8. Do not pull or carry by cord. Do not use the cord as a handle, close a door on the cord or pull cord around sharp edges or corners. Do not run the vacuum cleaner over the cord. Keep the cord away from heated surfaces.
9. Do not put any objects into openings. Do not use with any openings blocked and do not restrict airflow. Keep all openings free of dust, lint, hair or anything that might reduce airflow.
10. Keep hair, loose clothing, fingers and all parts of the body away from openings and moving parts.
11. Do not pick up hot coals, cigarette butts, matches or any hot, smoking or burning objects.
12. Do not pick up flammable or combustible materials (lighter fluid, petrol, kerosene etc.) or use in the presence of explosive liquids or vapours
13. Do not vacuum up harmful or toxic materials (chlorine, bleach, ammonia, drain cleaner etc.).
14. Do not vacuum up hard or sharp objects such as glass, nails, screws, coins, etc.

15. Do not use without ALL of the filters in place.
16. Take extra care when vacuuming on stairs.
17. Keep vacuuming area well lit.
18. Store the vacuum cleaner in a cool, dry area.
19. Turn off the on/off switch before unplugging the vacuum cleaner
20. Use only SAA-approved 10 amp extension cords. Non-approved cords may overheat. Care should be taken to arrange the cord so that the cord cannot be tripped over.



WARNING: Always switch off and unplug the vacuum cleaner from the electrical outlet before assembling, opening or emptying the dirt container, or before connecting/disconnecting the attachments.



CAUTION: The vacuum cleaner is a very powerful unit. Before plugging the cord into the electrical outlet, make sure the switch is in the 'off' position.



IMPORTANT: If the inlet, hose or telescopic tube is blocked, switch off the vacuum cleaner and remove the blockage(s) before re-starting the vacuum cleaner. See Maintenance: Clearing blockages.



IMPORTANT: Washing filters maintains vacuum performance. Vax recommends that they should be checked and cleaned periodically (depending on the level of use). Make sure all filters are completely dry before inserting back into the vacuum cleaner.



IMPORTANT: The motor is equipped with a thermal cut-out. If for any reason the unit should overheat, the thermostat will automatically turn the unit off. Should this occur, unplug the vacuum cleaner from the electrical outlet and turn off the switch. Remove dirt container and empty. Clean filters. Allow the unit to cool for approximately one (1) hour. To re-start, plug into an electrical outlet and switch back on.

This machine is intended for household use only, and NOT for commercial or industrial use.

PLEASE KEEP THESE INSTRUCTIONS FOR FURTHER USE.

Operation

Keep your Vax like new

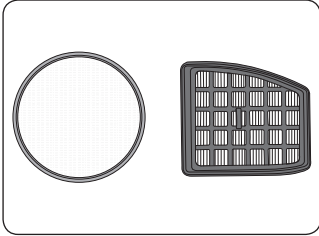

! **IMPORTANT:** The condition of the filters affects the performance of your machine. Please check and wash filters periodically (depending on the level of use). For full cleaning instructions, see pages 5 and 6.

! **IMPORTANT:** Do not use the vacuum cleaner without all of the filters in place.

Assembling your vacuum cleaner

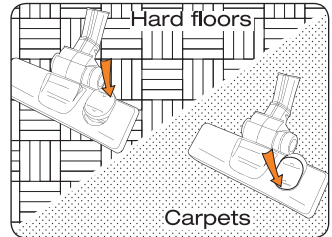
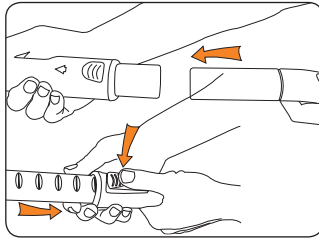
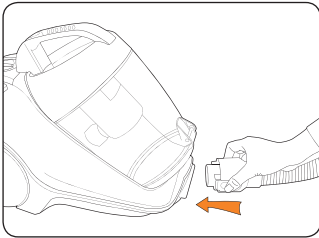

NOTE: The Turbo brush, hard floor tool, crevice tool, upholstery tool and dusting brush can all be attached directly to the telescopic tube or hose handle. The Turbo tool should be attached via the supplied connector.

Operating the appliance

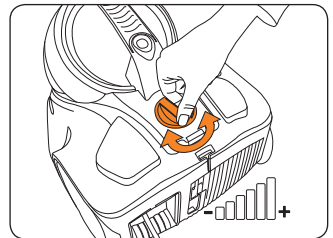
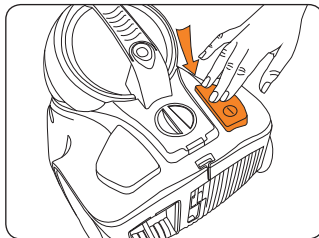
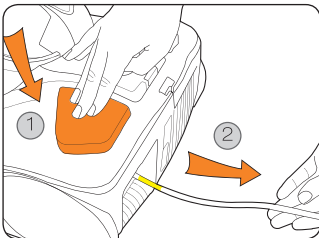

NOTE: Fully unwind the power cord. A yellow mark on the cord indicates the recommended cord length. Do not exceed the cord length beyond the yellow mark.

Maintenance (Keep your Vax as good as new)

Packing away and storage

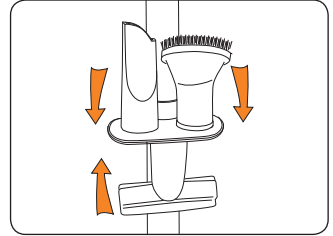
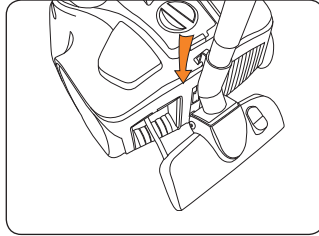
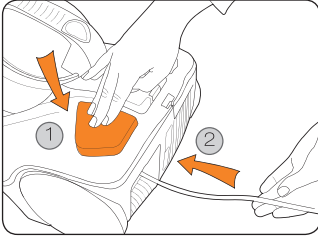

NOTE: For convenience there is a parking slot located at the rear of the vacuum cleaner where the floor head and tubes can be attached for storage and carrying.

Emptying and cleaning the dirt container

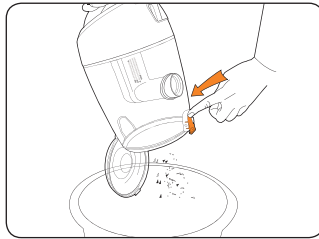
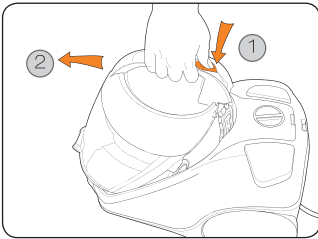

Cleaning the pre-motor filter

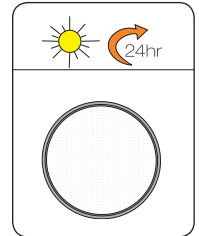
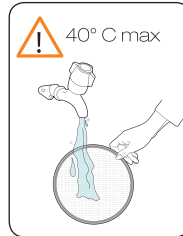
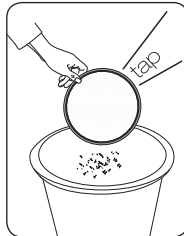

Maintenance (Keep your Vax as good as new)

Cleaning the shroud

NOTE: The shroud is accessed by removing the dirt container lid and is located underneath the pre-motor filter.

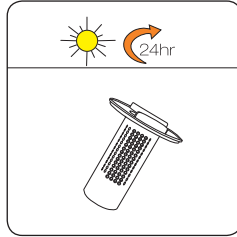
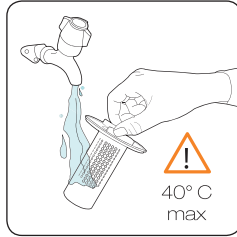
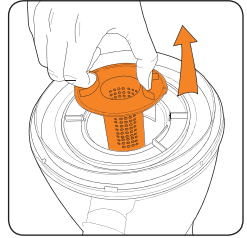
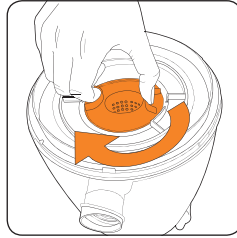

Cleaning the post-motor filter (DO NOT WASH post-motor filter)

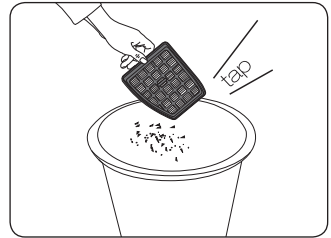
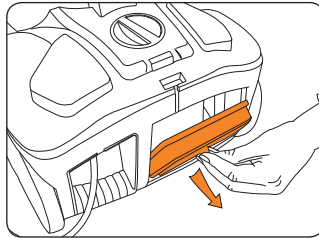
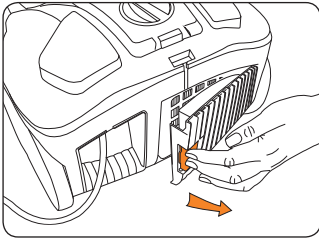

Maintenance (Keep your Vax as good as new)

Clearing blockages

⚠ WARNING: To reduce the risk of electric shock, the power cord must be disconnected before performing maintenance/troubleshooting checks. Turn the vacuum cleaner off and unplug from the electrical socket.

Hose blockages

The flexible hose may be disconnected from the vacuum cleaner. Carefully remove any blockages found and reconnect the hose securely.

Accessory blockages

Remove accessory from the hose/telescopic tube. Carefully remove the blockage and return to the cleaner.

Removing blockages from the Turbo tool (some models only)

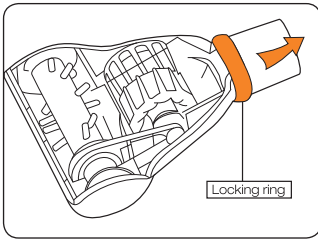

Turn the Turbo tool over and slide off the locking ring.

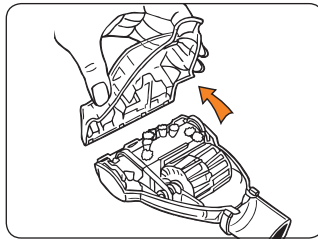

Detach lower housing and remove blockage.

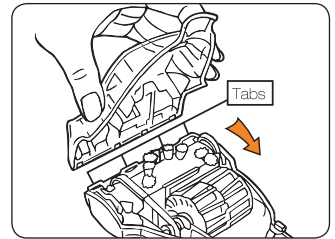

To re-assemble the Turbo tool, ensure that the tabs are engaged and pivot the lower housing closed. Slip the locking ring over the neck of the Turbo tool and into the groove to finish.

Removing blockages from the Turbo brush (some models only)

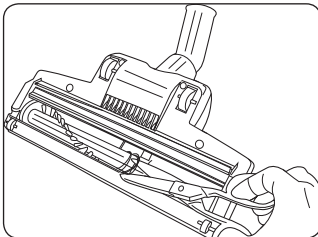

Switch the vacuum cleaner off and disconnect the power plug from the electrical outlet.

Lay the Turbo brush on a flat surface and turn over to expose the brushbar. Using a pair of scissors, cut through any threads or hairs caught around the brushes and brushbar.

Be careful not to cut through the brush bristles.

FAQ's



WARNING: To reduce the risk of personal injury, unplug the hard floor cleaner before performing maintenance/troubleshooting checks.

Problem	Solution
Is there an accessory missing?	<p>Check the 'Parts Overview' page in this guide to make sure the part is definitely included in your unit.</p> <p>If it is missing, we're here to help. Simply call us on AU: 1300 361 505 NZ: 0800 800 900</p>
Why won't the vacuum cleaner pick up?	<p>The dirt container may be incorrectly installed; remove the dirt container from the unit by pressing the dirt container release catch and then reattaching it to the unit, ensuring it is locked firmly back into place.</p> <p>The filter may be clogged; refer to 'Maintenance: Cleaning the filters' on pages 5 and 6.</p> <p>The dirt container may be blocked; refer to 'Maintenance: Emptying and cleaning the dirt container' on page 5.</p>
Why is dust escaping from the vacuum?	<p>The filter may be clogged; refer to 'Maintenance: Cleaning the filters' on pages 5 and 6.</p> <p>The dirt container may be blocked; refer to 'Maintenance: Emptying and cleaning the dirt container' on page 5.</p> <p>The dirt container may be incorrectly installed; remove the dirt container from the unit by pressing the dirt container release catch and then reattaching it to the unit, ensuring it is locked firmly back into place.</p>
What do I do if the unit/an accessory becomes damaged or broken?	<p>We're here to help. Simply call AU: 1300 361 505 NZ: 0800 800 900 or visit vax.com.au</p>
Why won't the accessories pick up properly?	<p>Hose blockages: remove the hose from the unit. Carefully remove any blockages found and reconnect hose securely.</p> <p>Accessory blockages: remove accessory from handle/tube. Carefully remove blockage and reattach to the vacuum cleaner.</p> <p>The accessory may be faulty. Simply call us on AU: 1300 361 505 NZ: 0800 800 900 for assistance.</p>
Why will the vacuum cleaner not run?	<p>It may not be plugged into the electrical outlet correctly; ensure that the plug is pushed in securely.</p> <p>The electrical outlet may not be working properly; check the fuse or breaker, or consult an electrician.</p> <p>The motor thermostat may have tripped; switch off and unplug the vacuum cleaner, and leave for one hour before switching the cleaner back on.</p>

we're here to help

Instead of taking me back to the shop, simply call:

AU: 1300 361 505
NZ: 0800 800 900

vax.com.au

This does not affect your statutory rights.

Other Information

Vax Service & Help

Vax Careline:

Australia 1300 361 505

New Zealand 0800 800 900

Monday-Friday 8.30am to 5.00pm

If you have queries or concerns about using your Vax, call the Vax Careline. Calls are charged at the standard local rate. Please make a note of the serial number and model number of the vacuum cleaner before calling.

For the nearest Service Agent, please call the Vax Customer Careline or visit www.vax.com.au

Technical Specification

Voltage: 220-240V ~50Hz

Wattage: 2400W

Capacity: 4L

Filters: Pre-motor filter (washable)
HEPA H12 antibacterial post-motor filter (tap to clean – do not wash)

Cord length: 8m (approx)

Weight: 5.9kg (approx)

Subject to technical change without notice.

EEC Statement of Compliance

Manufacturer/EEC importer: Vax Limited, hereby on our own responsibility, declare that the Power 7 series is manufactured in compliance with the following Directives:

Safety: 2006/95/EC Low Voltage Directive

EMC: 2004/108/EC Electromagnetic Compatibility Directive



Waste electrical products should not be disposed of with household waste. Please recycle where facilities exist. Check with your Local Authority or retailer for recycling advice.





Performance is everything.™

Distributed by Techtronic Industries Pty. Ltd.
Level 1, 660 Doncaster Road, Doncaster, Australia 3108.
www.vax.com.au Service Line: AU: 1300 361 505 / NZ: 0800 800 900